

# SANY ROAD HEADER 三一掘进机

Product Brochure  
产品手册

# SANY





QUALITY CHANGES THE WORLD

Company Profile

03

SANY Roadheader

05

SANY Engineering Roadheader

09

SANY Mining Roadheader

11



## Company Profile

Founded in 2004, SANY Heavy Equipment Co., Ltd. is a large construction equipment manufacturer and one of the core business enterprises of SANY Group – a global market pioneer of equipment manufacturing. SANY Heavy Equipment specializes in the research and development, manufacturing and marketing of mining machinery, set of equipment for coal excavation, mining, and transportation. It has more than 50 categories of leading products in the world, such as the off-highway mining truck, dump truck, mining and tunneling machine, hydraulic support, roadheader, drag conveyor, coal cutter, etc.

### Products' Footprints

With 18 years of constantly innovation and moving forward, SANY Heavy Equipment has delivered its products to more than 20 countries and regions such as Russia, India, Indonesia, Brazil, Argentina, Ukraine, Turkey, Mongolia, Poland, South Africa, West Africa, Vietnam, Thailand, the Philippines, etc. It has established 13 domestic subsidiary companies and its 24h sales and services cover 4 continents. SANY Heavy Equipment keeps exploring more possibilities to expand its reach and innovate its way of doing business as well as to raise the standard and answer the call for new market needs.





## Innovation and Research

Consisting of the Research and Development Departments of Excavation, Intelligent Technology, Wide-Body Dump Truck, Purified Water Support, and Coal Cutter, the Research Institute of SANY Heavy Equipment has been recognized as Chinese National Technical Center and High-Tech Enterprise. It has a National Postdoctoral Research Workstation, a first Academician Workstation in industry, a Continental Engineering Center and a Continental Engineer Laboratory. It also has passed the information security certification of CNAS (China National Accreditation Service for Conformity Assessment) and American standard ANAB (ANSI-ASQ National Accreditation Board).

## Working on the Future

SANY Heavy Equipment is a forward-looking company that was born in a time of change and now looks for any opportunity in those changes that will lead the way to the future. It is unleashing the power of data in the connectivity of machines, realizing smart manufacturing and autonomous operation with some models. The efforts to add a new electric product portfolio makes SANY Heavy Equipment stand out in today's digital world and is also part of its sustainable solutions.



# SANY Roadheader

Intelligent Roadheader

# Heading Monster



## Product Highlights

### Remote control

 Through the combination of wireless and wired, one-key automatic cutting is realized, and the control distance is more than 500m.

### Highly intelligent

 Autonomous navigation, slope tracking, pose error  $\leq 0.1^\circ$ . Heading angle errors  $\leq 0.15^\circ$ .

### High security

 Electronic security system, with the function of proximity identification and alarm for personnel in dangerous areas.

### Fault warning

 Equipped with a complete sensor network, online monitoring of working conditions, early warning and alarm of faults.

### Efficient cutting

 Adaptive cutting technology, identify the hardness of coal and rock, and adjust the cutting feed speed independently.

### 3D simulation

 Combination of virtual and real attitude coordinates, real-time display and control application of roadheader position.

**EBZ160i**

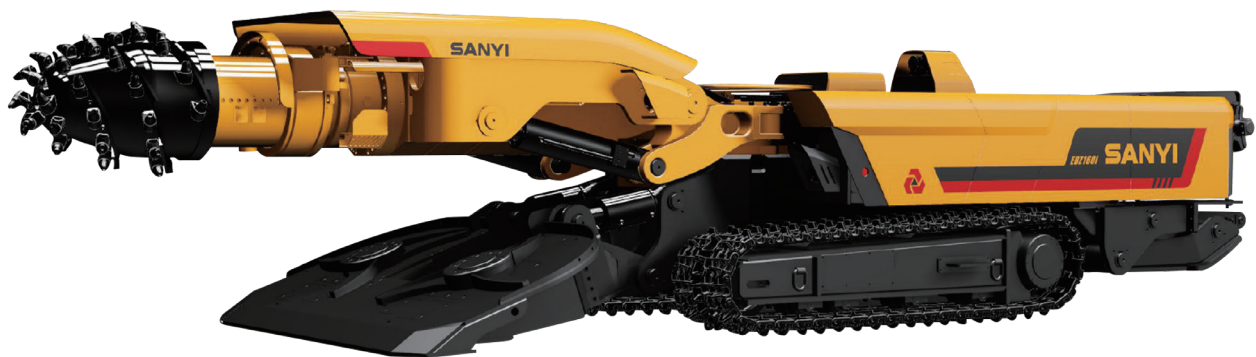

**Technical Data**

Project	Parameter
Positioning cutting height (m)	2.3~5.3
Positioning cutting width (m)	3.5~5.75
Gradeability(° )	± 20
Working slope (° )	± 18
Unilateral compressive strength of Max/suitable in cutting rock	≤80/60
Dinting depth	247
Rotating speed of cutting head/ telescopic length(rpm/mm)	46/23/550
Loading capacity (m <sup>3</sup> /min)	3.5
Ground clearance (mm)	260
Cutting motor power (kW)	160/100
Oil pump motor power (kW)	90

Project	Parameter	
Maximum non-removable size (length × width × height) (m)	body frame	3.65 × 1.16 × 1.32
	front chute of the first conveyor	3.80 × 0.59 × 0.57
	rear support frame	1.21 × 2.27 × 1.10
Maximum weight of non-removable parts (kg)	body frame	5400
Machine weight (t)	second conveyor	49

# SANY Roadheader

Suitable for all/half coal seam

## Coal-Rock Roadway



### Product Highlights

#### Swing tail technology



With application of universal tail swing technology, the conveyor can adjust the direction of discharge port as required to realize adjustable height and lateral swing for the discharge port.

#### Full nozzle cutting head



Each pick seat on the cutting head is designed with a cooling water channel to improve the cooling effect of the pick.

#### Double telescoping drive technology for cutting unit



This technology solves the unbalanced load problem and guarantees the highly reliable working of the bearings and seals.

#### Internal spray technology



The internal spray system with proprietary patent technology features reliable performance and high reliability and repairability.

#### High reliability



The critical and significant components are over 3 times of safety coefficient. They have passed the in-plant repeated durability tests and verification to achieve long working life. The conveyance system adopts high-strength wearing plates to prolong the wearing life by 3~5 times.

#### Super-wear resistant cutting teeth



The premium tungsten-cobalt alloy cutting teeth feature high strength, high wear resistance and low loss.



**EBZ200R**



Overall dimensions(m):13.7x2.6x1.85

**Technical Data**

ITEM	PARAMETER
Width of Mouldboard (m)	3.6/3.2/3.0
Width across tracks (m)	2.6
Cutting height from the stationary position (m)	2.5 ~ 5.2
Cutting width from the stationary position (m)	4.0 ~ 6.7
Unilateral compressive strength of Max/suitable in cutting rock (MPa)	≤85/65
Cutting motor power (kW)	200/110
Rotate speed of cutting head (rpm)	46/23
Telescoping capacity (mm)	650
Lateral swing range of first conveyor tail swing (°)	±40
Discharge height range of first conveyor tail swing (m)	1.16 ~ 1.93
Oil pump motor power (kW)	132
Ground pressure (MPa)	0.16
Undercut (mm)	400
Power supply voltage (V)	1140
Grade ability (°)	±18

ITEM	PARAMETER	
Dimension of maximum undetectable part (L*W*H) (m)	Body frame	3.13×1.39×1.5
	First conveyor front chute	3.0×0.97×0.88
	Rear support frame	2.47×1.63×1.4
Weight of maximum undetectable part (kg)	Body frame	6100
Total weight (t)	-	61
Gross power(kW)	-	332
Pump displacement(ml/r)	-	190+145
Height of cutting portion(m)	-	2.35

**SANY** | SANY Heavy Equipment

# SANY Roadheader

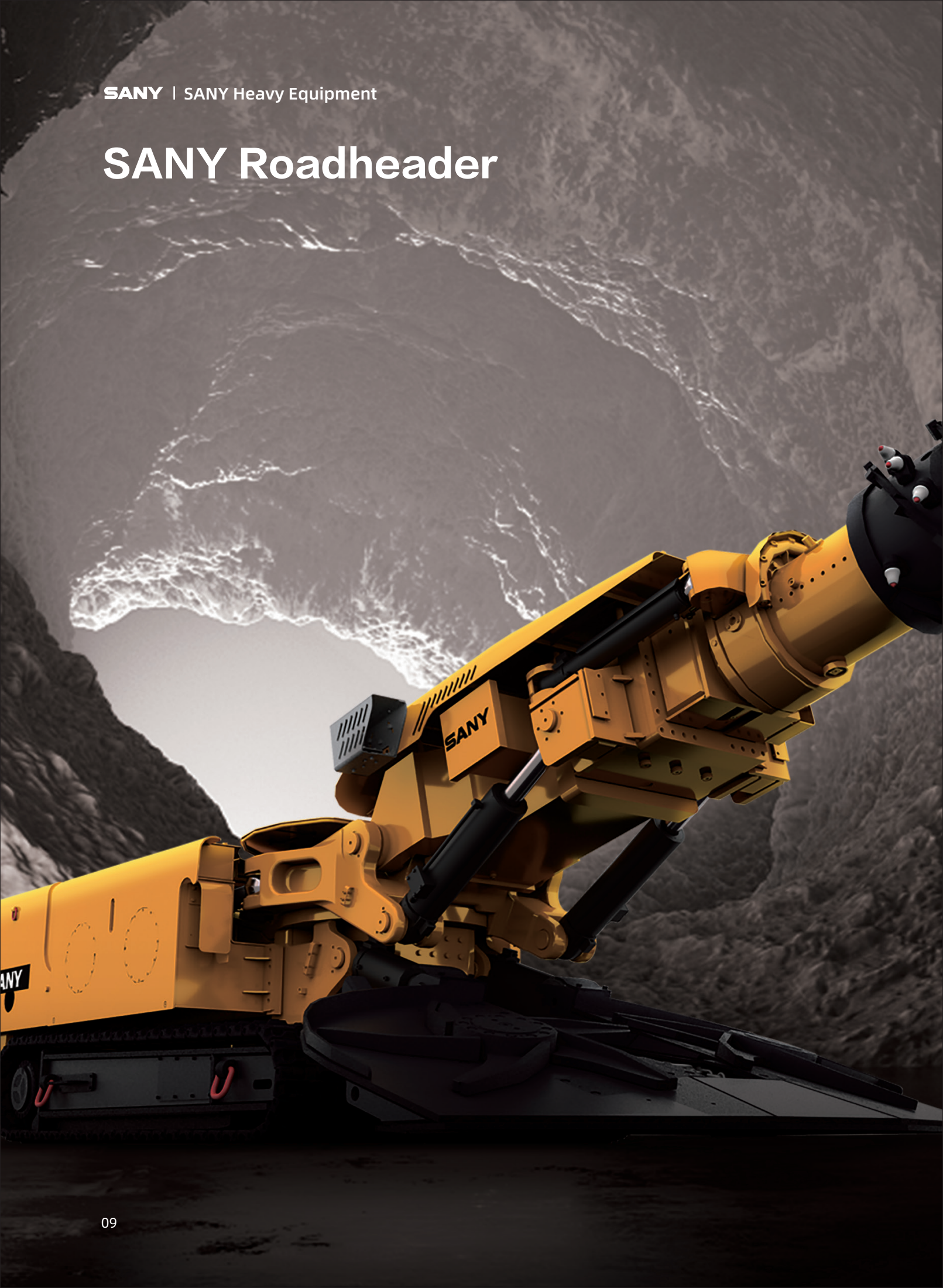

**EBZ200RUS**



**Technical Data**

ITEM		PARAMETER
Dimension of maximum undetectable part (L*W*H) ( m )	Frame	3.13 × 1.39 × 1.5
	Front chute	2.81 × 0.78 × 0.7
	Rear support	2.47 × 1.63 × 1.4
Weight of maximum undetectable part ( kg )	Frame	6100
Total weight ( t )		55
Gross power ( kW )		310
Hydraulic pump ( ml/r )		145+145
Height with horizontal cutting head ( m )		2.35
Overall dimensions ( m )		10.85 × 2.6 × 1.8

ITEM	PARAMETER
Width of shovel ( m )	3.6
Width of outer side of both pedrails ( m )	2.6
Positioning cutting height ( m )	2.5~5.2
Positioning cutting width ( m )	4.0~6.7
Unilateral compressive strength of Max/suitable in cutting rock ( MPa )	≤85/65
Cutting motor power ( kW )	200/110
Rotate speed of cutting head ( rpm )	46/23
Cutting head boom stroke ( mm )	650
Oil pump motor power ( kW )	110
Ground pressure ( MPa )	0.15
Undercut ( mm )	400
Power supply voltage ( V )	1140
Grade ability ( ° )	± 18

**SANY** | SANY Heavy Equipment

# SANY Roadheader



**EBZ260R**



**Technical Data**

Item		Parameter
Dimension of maximum undetectable part (L*W*H) (m)	Frame	3.03 × 1.40 × 1.39
	Front chute	3.5 × 0.7 × 0.6
	Motor tank	2.13 × 1.80 × 0.92
Weight of maximum undetectable part (kg)	Frame	7701
Total weight (t)		95
Gross power (kW)		420
Hydraulic pump (ml/r)		190+145+145
Height with horizontal cutting head (m)		2.47
Overall dimensions (m)		15.3 × 2.62 × 1.85

Items	Parameter
Width of shovel (m)	3.6
Width of outer side of both pedrails (m)	2.62
Positioning cutting height (m)	3.3~5.1
Positioning cutting width (m)	4.2~6.2
Unilateral compressive strength of Max/suitable in cutting rock (MPa)	≤100/80
Cutting motor power (kW)	260/200
Rotate speed of cutting head (rpm)	54/27
Lateral swing range of first conveyor tail swing (°)	±40
Discharge height range of first conveyor tail swing (m)	1.375~2.0
Oil pump motor power (kW)	160
Ground pressure (MPa)	0.17
Undercut (mm)	200
Power supply voltage (V)	1140
Grade ability (°)	±18

# SANY Roadheader— Whole Rock

Suitable for all coal seam /half coal seam/all rock seam

## Hard Rock Heading Monster



### Product Highlights

#### Extensive scope



5,100mm cutting height and 6,300mm width guarantee extensive application scope.

#### Full nozzle cutting head



Each pick seat on the cutting head is designed to with a cooling water channel to improve the cooling effect of the pick.

#### Powerful rock breaking



260kW cutting power features strong power.

#### Wireless remote control



The remote controller is configured to operate the equipment through wireless remote control system, which provides great safety guarantee for the operators.

#### High safety guarantee



The multipole emergency stop buttons are installed for quick treatment of emergencies and the multiple sensors (including electric leakage and over-current sensors) are installed to guarantee the working safety of equipment.

**EBZ260RUS**



Overall dimensions(m): 12.4x2.62x1.85

**Technical Data**

ITEM	PARAMETER
Width of loading apron (m)	3.6/3.2/3.0
Width across tracks (m)	2.62
Cutting height from the stationary position (m)	3.3 ~ 5.1
Cutting width from the stationary position (m)	4.2 ~ 6.2 (with standard 3.6m wide loading apron)
Unilateral compressive strength of Max/suitable in cutting rock (MPa)	≤100/80
Cutting motor power (kW)	260/200
Rotate speed of cutting head (rpm)	54/27
Oil pump motor power (kW)	160
Ground pressure (MPa)	0.16
Undercut (mm)	200
Power supply voltage (V)	1140
Grade ability (°)	±18

ITEM	PARAMETER	
Dimension of maximum undetectable part (L*W*H) (m)	Body frame	3.03×1.40×1.39
	First conveyor front chute	3.35×0.78×0.6
	Motor tank	2.13×1.80×0.92
Weight of maximum undetectable part (kg)	Body frame	7690
Total weight (t)	-	89
Gross power(kW)	-	420
Pump displacement(ml/r)	-	190+145+145
Height of cutting portion(m)	-	2.47

# STR260/5

## SANY Engineering Roadheader

Suitable for all coal seam/half coal seam/all rock seam



### Product Highlights

#### Complete equipment



The enclosed cab mitigates the noise and dust harms and the humanized equipment (such as cable reel) make operating more labor-saving.

#### High safety guarantee



The multipole emergency stop buttons are installed for quick treatment of emergencies. The electrical system prevents electric leakage and provides overcurrent protection to guarantee the working safety of equipment.

#### Extensive scope



5,100mm cutting height and 6,300mm width guarantee extensive application scope.

#### Easy maintenances



The expert malfunction diagnosis system ensures quick judgment and solving of malfunctions.

#### Powerful rock breaking



260kW cutting power features strong power.



## Technical Data

Item		Unit	Parameter
Positioning cutting height	Arched roadway	m	3.3 ~ 5.1
	Rectangular roadway (equipped with deduster)	m	3.3 ~ 5.1
	Rectangular roadway (deduster unavailable)	m	3.3 ~ 5.1
Positioning cutting width	Standard mouldboard width: 3.6m	m	4.2 ~ 6.2
	Optional mouldboard width:3.2m	m	3.6 ~ 6.2
	Optional mouldboard width:3m	m	3.8 ~ 6.2
Grade ability		°	±18
Unilateral compressive strength of Max/suitable in cutting rock		MPa	≤ 100/70
Adaptable roadway characteristic of roadheader			III ~ IV
Dinting depth		mm	200
Power of cutting motor		kW	260
Rotating speed of cutting head		r/min	37
Mode of loading			5-tooth star wheel
Mode of conveyor			Side dual-chain scraper type
Dimension of Max. undetectable part (L*W*H) (m)	Body frame	m	4.18×1.42×1.4
	Front chute	m	3.35×0.69×0.63
	Motor box	m	2.24×1.82×0.92
Traveling speed		m/min	0-6.5
Rotary speed of star wheel		r/min	33
Speed of conveyor chain		m/min	66
Volume of oil tank		L	750
Overall dimensions	Length	m	14.775 (Standard)
		m	Standard mouldboard width: 3.6m (optional mouldboard width 3m/3.2m)
	Width	m	Width of outer side of both pedrails 2.62
		m	Width of complete machine 2.6
		m	Body height :1.8m
Height	m	Highest point with horizontally arranged cutting head :2.3m	
	t	80	
Total weight		t	80
Power supply voltage		V	1140
Power of oil pump motor		kW	132
Gross power		kW	467 (Including deduster)
PH value of supply water			6 ~ 8
Required water pressure supplied undermine		MPa	3 ~ 8
Required/minimum cooling water capacity		L/min	120/30
Weight of Max. undetectable part (body frame)		kg	9060
Connecting vehicle height 1.8m		m	Depth of compartment 2.5m
Track width		mm	650
Hydraulic pump		ml/r	190+190
Ground pressure		MPa	0.157
Ground clearance		mm	200

## Overall Dimensions

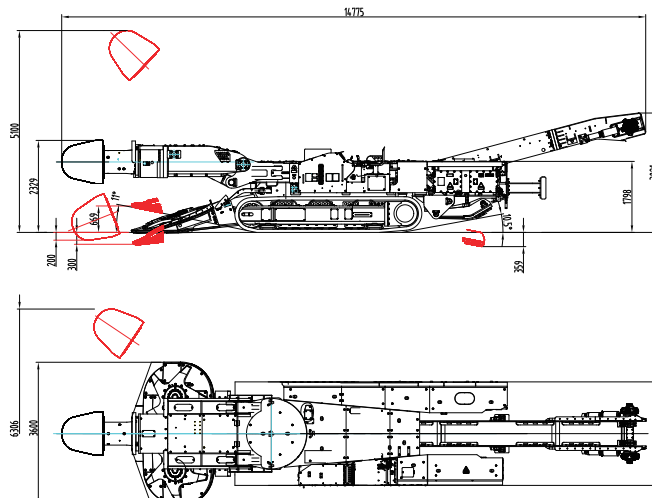

**SANY** | SANY Heavy Equipment

# SANY Mining Roadheader

Suitable for non-coal such as potassium/sodium salt ore



# Multi-functional Gold Miner

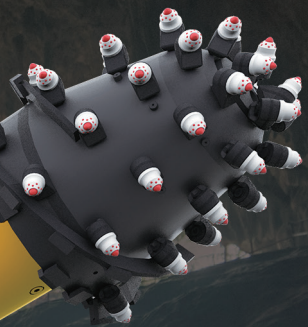

## Product Highlights

### Mechanical Excavation

 It features advanced mining technology including mechanical excavation, remote control, and automatic cutting instead of the conventional blasting and mining of non-coal mines.

### High Efficiency

 It features a continuous mining process including mechanical rock breaking, shoveling, and transportation, with an efficiency of two times of blasting when the rock hardness (f) is less than 8.

### High Security

 It features limited rock disturbance, cross-sectional regularity, surrounding rock stability, no blasting operation, efficient equipment, and personnel of the working surface for higher security.

### Simple Process

 Compared with blasting operation, it features a 45% reduction in relevant processes including drilling, charging, wire blasting, ventilation, shoveling, and transportation.

### Excellent Tunnel Formation

 It features limited rock disturbance and damage, tunnel flatness, and regularity, with a more than 30% reduction of support and twice the efficiency.

### Low Operating Cost

 The operating costs consist of manpower, utilities, cutting pick consumption, and maintenance. Compared with blasting operation, it features a 20% reduction of cost when the rock hardness (f) is less than 8.

**SANY Mining Roadheader**

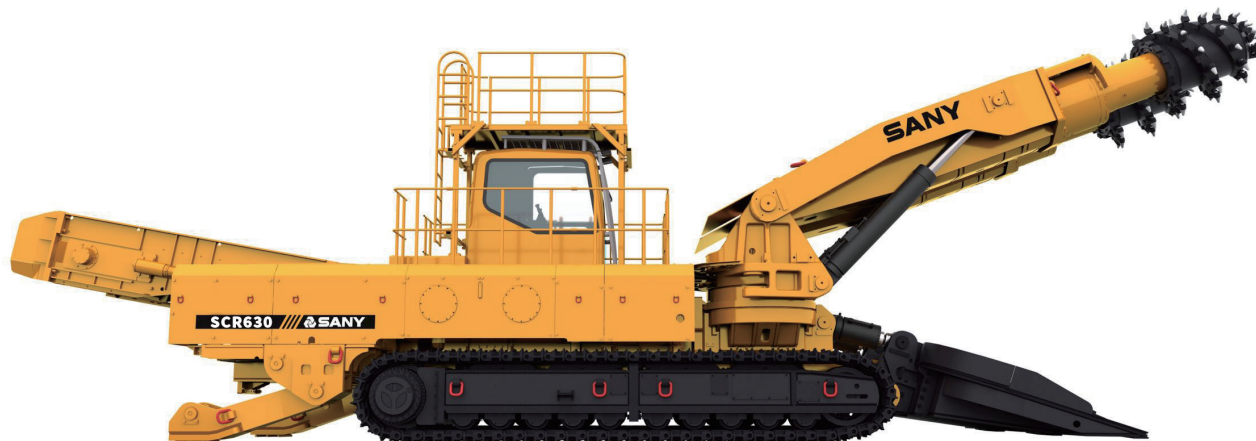

**Technical Data**

Main parameter	Product model	SCR630
Overall length (m)		16.8
Overall height (m)		4.5/ Height of cutting portion 3.7
Width of mouldboard(m)		5.5
Width between track (m)		4
Width of cut (m)		9.15
Height of cut (m)		4.5-6.8
Grade ability (°)		±16
Max/economic unidirectional pressure resistance of rock (MPa)		60
Undercut (mm)		330
Ground pressure (MPa)		0.2
Power supply voltage (V)		1140
Cutting motor power (kw)		2×315
Pump displacement (ml/r)		190+145+145
Oil pump motor power (kW)		200
Dimension of maximum undetectable part (L*W*H)		4.18 ×1.40×1.4m
Weight of maximum undetectable part (body frame) (t)		10.5
Gross power (kW)		867
Gross weight (t)		178
Rotary speed of star wheel (r/min)		54

## SANY Mining Roadheader



## Technical Data

Main parameter	Product model	SCR520A
Overall length (m)		16.8
Overall height (m)		4/ Height of cutting portion 3.7
Width of mouldboard(m)		5.5
Width between track (m)		4
Width of cut (m)		9.7
Height of cut (m)		4.0-6.57
Grade ability (°)		±15
Max/economic unidirectional pressure resistance of rock (MPa)		60
Undercut (mm)		340
Ground pressure (MPa)		0.17
Power supply voltage (V)		1140
Cutting motor power (kw)		2×260
Pump displacement (ml/r)		260+190
Oil pump motor power (kW)		200
Dimension of maximum undetectable part (L*W*H)		2.53×3.41×1.47
Weight of maximum undetectable part (body frame) (t)		10.5
Gross power (kW)		757
Gross weight (t)		168
Rotary speed of star wheel (r/min)		37

EBZ200M-2



Parameters Table

The main parameters		Product model	EBZ160M-2	EBZ200M-2
Cutting range	Positioning cutting height (m)		3.0~4.8	3.1~5.19
	Positioning cutting width (m)		3.8~5.5	3.8~6.6
Anchor range	Anchor height (m)		3.0~4.8	3.1~4.8
	Anchor width (m)		3.8~5.0	3.8~5.0
Cutting power			160/100kW	200/110kW
One-way compressive strength of rock that can be cut/economically cut (MPa)			≤80/60	≤85/65
Cutting head speed (rpm)			46/23	46/23
Cutting head telescopic amount (mm)			550	550
Number of bolters			2	2
Bolting machine torque (N·M)			300	300
Bolting machine speed (r/min)			450	450
Support size (length × width) (mm)			1000×3700	1000×3700
Supporting force (KN)			50	50
Maximum part size (mm)	Body frame		3.60×1.16×1.33	3.39×1.39×1.5m
	Front chute		3.80×0.60×0.56	2.81×0.70×0.60m
	Rear support frame		1.21×2.28×1.10	2.47×1.63×1.4m
Maximum part weight (t)			5.4	6.1
Machine weight (t)			≈48	≈57

**EBZ260M-2**



**Parameters Table**

The main parameters		Product model	EBZ260M-2
Cutting range	Positioning cutting height (m)		3.5~5.0
	Positioning cutting width (m)		4.6~6.1
Anchor range	Anchor height (m)		3.5~5.0
	Anchor width (m)		4.6~6.1
Cutting power			260kW
One-way compressive strength of rock that can be cut/economically cut (MPa)			≤100/80
Cutting head speed (rpm/mm)			37
Number of bolters			2
Bolting machine torque (N·M)			300
Bolting machine speed (r/min)			450
Support size (length × width) (mm)			2900×2400
Supporting force (KN)			20
Maximum part size (mm)	big body part		3.03×1.40×1.43m
	rear support		1.9×3.08×1.33m
	1st sliding table		3.98×0.3×0.41m
Maximum part weight (t)			7.8

Even the mining machine



Parameters Table

The main parameters	Product model	ML360A
Machine weight (t)		90
Body length (m)		11.9
Cutting width (m)		3.65
Body height (m)		1.7
Maximum non-removable part size (m)		body frame 2.8×1.7×1.4
Maximum weight of non-removable parts (t)		8.8
Positioning cutting height (m)		Rectangular roadway 1.9 ~ 4.5
Maximum/Economic Cutting Coal Unidirectional Compressive Strength (MPa)		80/50
Total power of the whole machine (kW)		763
Cutting Motor Power (kW)		360
Production capacity (t/min)		15 ~ 25
Moving speed (m/min)		0 ~ 18
Ground specific pressure (MPa)		0.21
Undercover Depth (mm)		200
Supply voltage (V)		1140



Even the windlass



Parameters Table

The main parameters	Product model	EJM270
Machine weight (t)		100
Body length (m)		11.4
Cutting width (m)		4.9 ~ 5.8
Body height (m)		2.6
Positioning cutting height (m)		rectangular roadway 2.8 ~ 3.8/3.3 ~ 4.4
Maximum/Economic Cutting Coal Unidirectional Compressive Strength (MPa)		60
Total power of the whole machine (kW)		574
Cutting Motor Power (kW)		270
Production capacity (t/min)		12 ~ 28
Moving speed (m/min)		0 ~ 12
Ground specific pressure (MPa)		0.27
Undercover Depth (mm)		200
Supply voltage (V)		1140
Gradeability (°)		±16

# Drill-Loader Machine

# Drilling Specialist



## Six main points

### Wide applicability



Road, railway, water conservancy engineering tunnel and mining

### system balance



Best match of mechanical, electrical and hydraulic properties

### High stability



When drilling and receiving materials, the equipment has little vibration

### Perfect function



It can realize the functions of drilling, loading, transportation, roadway repair and other functions

### High drilling efficiency



Double triangle hydraulic translation drill arm, reliable positioning and high drilling efficiency

### Large drilling range



35m<sup>3</sup> one-time positioning to complete full-section drilling

CMZY2-300/35



Parameters Table

The main parameters		Product model	CMZY2-300/35 Double arm drill-loader machine
Dimensions	Length (m)		10.6
	Width (m)		2.6(Shovel board)/2.25 (Crawler)
	Height (m)		2.5 (guard plate) /2.85 (ceiling)
Maximum non-removable size (L×W×H)	Front body frame (m)		2.69×0.99×1.25
	Front chute (m)		4.75×0.87×1.62
	Rear support frame (m)		2.1×1.25×0.76
Machine weight (t)			42 (Including second conveyour)
Maximum non-removable weight (t)			2
Rated output power (kW)			147 (Including second conveyour15)
Positioning drilling range (m)			6.8×4.75 (width x height)
Positioning range (m)			5.3×4.2 (width x height)
Loading capacity (m <sup>3</sup> /h)			300
Maximum depth of one drilling (m)			2.6
Drilling diameter (mm)			φ43 ~ φ76
Boom thruster compensation stroke (m)			1.25
Boom thruster pitch angle (°)			Up 90/ Down 6
Track width (mm)			600
Hydraulic pump displacement (ml/r)			145+145
Moving speed (m/min)			0 ~ 8.0
Track width (mm)			600
Undercover Depth (mm)			230
Body Ground Clearance (mm)			230
Fuel tank volume (L)			600
Ground pressure (MPa)			0.1

# SANY

